

2020



COMMERCIAL
INDUSTRIAL
RESIDENTIAL

LED

INDOOR/OUTDOOR LIGHTING CATALOG

ENERGY SAVING SOLUTIONS

FOR INTERIOR AND EXTERIOR SPACES



ETi Solid State Lighting – North America
Subsidiary of NVC International, one of
the largest lighting manufacturers in the
world.

We deliver high performing, high value
LED lighting products to commercial,
industrial, and residential consumers
across the U.S. and Canada.

Our new North American corporate
headquarters and 190,000 sq. ft.
distribution center is located in
Wheeling, IL.

To Order:
Call ETi SSL Customer Service
8 a.m. - 5 p.m., CST, Monday - Friday
1-855-ETI-SSL (1-855-384-7754)
www.ETiSSL.com



TABLE OF CONTENTS

COMMERCIAL/RESIDENTIAL INDOOR FIXTURES	
Recessed Downlights	3
Flushmount Ceiling Lights & Standard Downlights	5
Flushmounts-NightLightR	6
Flushmounts with Color Preference® Technology	7
Flushmounts-Single CCT	7
Spin Lights®	9
Under Cabinet Lights.....	10
Strip Lights.....	11
Wrap Lights.....	13
Flat Panels	15
Ceiling Lights & Shop/Task Lights	16
INDUSTRIAL LIGHTING FIXTURES	
High Bay	17
Vapor Tights	19
LED Tube Ready Fixtures	20
OUTDOOR LIGHTING FIXTURES	
Area Lights	21
Security Lights	21
Sports Lighting.....	22
Wall Packs.....	23
Shorebreaker Lighting®.....	24
Outdoor Flushmounts	24
HID REPLACEMENT LAMPS	
CR Series HID Replacement Lamps	25
PT Series HID Replacement Lamps.....	26
T8/T5 LINEAR REPLACEMENT LAMPS	
Ballast Bypass LED Glass Tubes-Double End Power.....	27
Ballast Bypass LED Tube-Shatter Resistant Glass-Double Ended Power & Retrofit Kits.....	28
EMERGENCY & EXIT LIGHTING FIXTURES	
Emergency Lights.....	29
Exit Signs.....	30



QUALITY, INNOVATION, AND VALUE

OUR CORE VALUES:

- Quality:** Superior product design, uncompromising components and material.
- Innovation:** New lighting technologies that improve quality of life and install quickly and easily.
- Value:** We deliver quality and innovation at a great price.



ETi's Color Preference® patented technology provides multiple CCT choices in one fixture. Colors range from 2700K to 5000K depending on the product. Simply move the switch on the back of the ETi fixture to obtain the desired ambiance for any room.

U.S. Patents - 10,091,855, 10,462,871, 10,492,262



All of our NightLightR™ models feature an integrated 2000K CCT night light hidden in the base of each light fixture. The light fixture can be switched from white light to night light using the rooms light switch. The warm 2000K indirect light creates a comforting glow at night.

U.S. Patent Pending



Like our Color Preference® technology, Lumen Boost™ allows users to select the best light output for their lighting area. Easily adjustable intensity meets the needs of different room sizes, adjust for user preferences, and activities.



The LowPro™ line of LED downlights is unmatched in the marketplace at a slim 1.3" profile. LowPro™ downlights are designed for difficult low clearance installations. These lights can be installed in ceiling locations that traditional downlights do not fit. Mounting guide plate accessories are now available for new construction/remodel projects.



SnapFit Mounting Systems™ is an innovative mounting system which makes installation quick and easy. Simply secure the bracket that is included with the ETi product to a j-box and snap the fixture into the bracket.



ETi is always developing innovative ways to install lighting fixtures to enhance the customer's experience. From wrap lights with hinged lens covers to screwing in fixtures with ETi's patented SpinLight® collection. ETi continues to develop technology that makes wiring fixtures a breeze.



U.S. Patent # 9500352, 9541270, D776326, CND Patent # 169113

RECESSED DOWNLIGHTS



Retrofit Existing Cans



NightLIGHTR

Integrated Night Light Trim
Emits Warm 2000K CCT Glow



4" Color Preference®
Downlight with Night Light Trim
Model # 53805102
Part # DL-4-625-907-SV-D
10.5W 625LM 120V 90CRI



6" Color Preference®
Downlight with Night Light Trim
Model # 53804102
Part # DL-6-67-907-SV-D
11W 670LM 120V 90CRI



ETi Advantage

- ✓ TRIAC dimmable
- ✓ Direct insulation contact IC rated
- ✓ UL wet rating
- ✓ No remote control needed, activated by wall switch
- ✓ Patented Color Preference® Technology 2700K, 3000K, 3500K, 4000K, or 5000K CCT

30 in 1 Downlight with Color Preference & Selectable Lumens

- 3 Level Lumen Adjust
- 5 x CCT Selectable
- 2 Trim Color Choices

LUMEN BOOST™



ETi Advantage

- ✓ TRIAC dimmable
- ✓ 2 Baffle Rings included
- ✓ Wet Rated
- ✓ 2700K, 3000K, 3500K, 4000K, or 5000K CCT
- ✓ 120V



4"
Model # 53802102
Part # DL-4-10-907-SV-D
15W



6"
Model # 53801102
Part # DL-6-11-907-SV-D
17W

COLOR PREFERENCE® RETROFIT KITS

- TRIAC Dimmable
- 120V
- 90CRI



2700K/3000K/4000K CCT
4" Downlight
Model # 53185142
Part # DL-4-10-901-SV-D
10W 625LM

5"/6" Downlight
Model # 53186401
Part # DL-6-11-901-SV-D
11W 800LM

3000K/4000K/5000K CCT
4" Downlight
Model # 53185143
Part # DL-4-10-902-SV-D
10W 625LM

5"/6" Downlight
Model # 53186311
Part # DL-6-11-902-SV-D
11W 800LM

LowPro Recessed Downlight 3", 4", 5"/6", & 6" Models Available 2700K/3000K/4000K/5000K CCT



CAN-LESS NEW CONSTRUCTION REMODEL PROJECTS

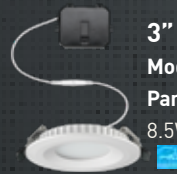

3"
Model # 53809111
Part # DL-3-47-906-SV-D
8.5W 470LM 120V

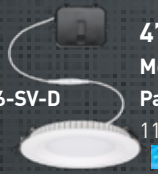

4"
Model # 53808211
Part # DL-4-65-906-SV-D
11W 650LM 120V

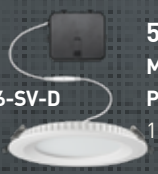

5"/6"
Model # 53807211
Part # DL-5-90-906-SV-D
15W 900LM 120V

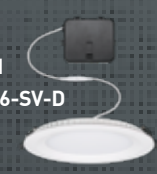

6"
Model # 53807102
Part # DLLP-6in-900L-9-4CP-TD
15W 900LM 120V

ETi Advantage

- ✓ Unmatched slim 1.3" profile
- ✓ IC insulation rating
- ✓ UL wet rating
- ✓ Meets NECA 410.16 requirement
- ✓ 5/6" model include a "goof ring" to fit 6" openings
- ✓ TRIAC dimmable



Black & Oil
Rubbed Bronze

Guide Plates available
for easy Installation &
Decorative Trim Rings
to Select.

COLOR PREFERENCE® DOWNLIGHTS FOR NEW CONSTRUCTION/REMODEL PROJECTS

120-277V 3000K/3500K/4000K/5000K



5"/6" Color Preference®
Downlight 0-10V Dimmable
Model # 53192211
Part # DL-6-80-903-MV-D
14W 800LM 90CRI



8"/10" Color Preference®
Downlight 0-10V Dimmable
Model # 53189111
Part # DL-8-30-903-MV-D
40W 3000LM 90CRI

DOWNLIGHT ACCESSORIES

Model #	Description	Compatible Model #
Extension Cord		
90600713	12' extension cord for LowPro downlights single pack	53809111, 53808211, 53807211, 53807102
90600714	20' extension cord for LowPro downlights single pack	53809111, 53808211, 53807211, 53807102
Trim		
90600734	3" ORB Trim for LowPro Down Light	53809111
90600735	4" ORB Trim for LowPro Down Light	53808211
90600736	6" ORB Trim for LowPro Down Light	53807102
90600729	6" Downlight Trim Kit for 5" LowPro	53807211
90600193	10" Trim for Color Preference® Downlight	53189111
Guide Plate		
70306101	Guide plate for LowPro downlight 3"	53809111
70307101	Guide plate for LowPro downlight 4"	53808211
70308101	Guide plate for LowPro downlight 5"	53807211

FLUSHMOUNT CEILING LIGHTS STANDARD DOWNLIGHTS



Decorative Color Preference® Low Profile Flushmounts and Ceiling Lights!
Simply secure the bracket to a j-box and snap the ETi fixture into the bracket.

SnapFit™
Mounting System



ETi Advantage

- ✓ Integrated 2000K Night Light easily controlled by on/off light switch!
- ✓ Stylish Low Profile Design
- ✓ Premium Samsung LEDs
- ✓ TRIAC Dimmable

New SnapFit Mounting System for New Construction and Remodeling Projects

NEW CONSTRUCTION

EASY INSTALLATION



SnapFit Mounting System designed for the new 11" Flushmount and 7.5" Ceiling Light

New Construction with SnapFit J-box bracket



Remodel with Spring Clips



SnapFit™
Mounting System

FLUSHMOUNTS

NIGHTLIGHTR™



11" & 16" Color Preference® Flushmount with Night Light



NIGHT LIGHT CAN BE TURNED ON/OFF BY TOGGING WALL LIGHT SWITCH!



Integrated Night Light Trim Emits Warm 2000K CCT Glow

NightLIGHTR NIGHT LIGHT TRIM EMITS WARM 2000K GLOW

11" FLUSHMOUNT 3500K/4000K/5000K CCT 14W 900LM 80CRI 120V



White Finish
Model # 56572113
Part # FMNL-11IN-900LM-8-CP3-SV-TD-WT

Brushed Nickel Finish
Model # 56572114
Part # FMNL-11IN-900LM-8-CP3-SV-TD-BN

Oil Rubbed Bronze Finish
Model # 56572115
Part # FMNL-11IN-900LM-8-CP3-SV-TD-ORB

7.5" CEILING LIGHT 3000K/4000K/5000K CCT 12W 800LM 80CRI 120V



White Finish
Model # 56568114
Part # FMNL-7.5IN-800LM-8-CP3-SV-TD-WT

Brushed Nickel Finish
Model # 56568116
Part # FMNL-7.5IN-800LM-8-CP3-SV-TD-BN

Black Finish
Model # 56568115
Part # FMNL-7.5IN-800LM-8-CP3-SV-TD-BK

STANDARD RETROFIT DOWNLIGHTS

4" Recessed Retrofit Downlight



Model # 53182201
Part # DL-4-625-827-SV-D
8W 625LM 120V 80CRI
2700K CCT TRIAC Dimmable



Model # 53182211
Part # DL-4-625-830-SV-D
8W 625LM 120V 80CRI
3000K CCT TRIAC Dimmable



Model # 53179111
Part # DL-6-18-930-SV-D
18W 1300LM 120V 90CRI
3000K CCT TRIAC Dimmable

5 7/8" Recessed Retrofit Downlight



Model # 53193101
Part # DL-6-67-827-SV-D
9W 670LM 120V 80CRI
2700K CCT TRIAC Dimmable



Model # 53193111
Part # DL-6-67-830-SV-D
9W 670LM 120V 80CRI
3000K CCT TRIAC Dimmable



Model # 53193141
Part # DL-6-67-840-SV-D
9W 670LM 120V 80CRI
4000K CCT TRIAC Dimmable

ETi Advantage

- ✓ Integrated warm 2000K night light**
- ✓ Patented 3 CCT Color Preference® technology
- ✓ TRIAC Dimmable
- ✓ Closet rated
- ✓ ADA compliant
- ✓ UL Damp Rated
- ✓ Impact resistant non-yellowing lens

Technology

- Integrated 2000K night light can be turned on/off by toggling wall light switch!
- 3 CCT Color Preference® technology delivers total choice of CCT: 3000K, 4000K, or 5000K

Control

- Dimmable with TRIAC dimmer

Features & Specifications

- 120V
- 80CRI
- Temp rating -4°F – 113°F
- IC rated for direct contact with insulation
- Meets NECA 410.16 requirements
- UL Damp Rated
- L70>50,000

*U. S.A. Patent 15/871,433, **Patent Pending



11" Color Preference® LED Flushmount with Night Light

Model # 56546103
Part # FMNL-11IN-900LM-8-CP5-SV-TD
14W 900LM 120V 80CRI 3000K/4000K/5000K CCT



16" Color Preference® LED Flushmount with Night Light

Model # 56549102
Part # FMNL-16IN-1400LM-8-CP5-SV-TD
22W 1400LM 120V 80CRI 3000K/4000K/5000K CCT

FLUSHMOUNTS

WITH COLOR PREFERENCE® TECHNOLOGY & SINGLE CCT



Flushmounts with Color Preference® Technology



Color Preference® technology allows the installer to easily select the preferred CCT from three or more settings!

Color Preference®
3000/4000/5000K 120-277V 90CRI

12" and 16" Models with Step Dimming Motion Sensor Available

ETi Advantage

- ✓ 4 Color Preference® Models to Choose From!
- ✓ Eliminates need to order and stock multiple color temperature models for each design
- ✓ Superior Optical Performance & Electronic Design
- ✓ Proprietary light engine eliminates LED "hot spots"
- ✓ Models are 0-10V Dimming
- ✓ Robust, Durable Construction
- ✓ Durable polycarbonate globe will not yellow over time and is shatterproof

✓ Powder coated, heavier gauge mounting housing means long corrosion free life

Energy Star approved
Suitable for both dry & damp locations
5 Year Warranty, L70 >50,000 Hrs

Color Preference® 3000/4000/5000K 120-277V 90CRI Size choices up to 16"

Robust, Durable Construction

- Durable polycarbonate globe is highly impact resistant and will not yellow over time
- Powder coated, heavier gauge mounting housing means long corrosion free life

12" Low Profile
Model # 54436511

Part # FM-12-16-902-MV-D-B
16W 1000LM 0-10V Dimmable



12" Low Profile with Motion Sensor
Model # 54436511-I

Part # FM-12-16-902-MV-D-B-OS
16W 1000LM 0-10V Dimmable

16" Low Profile
Model # 54437511

Part # FM-16-24-902-MV-D-B
24W 1600LM 0-10V Dimmable

16" Low Profile with Step Dimming Motion Sensor
Model # 54437511-I

Part # FM-16-24-902-MV-D-B-OS
24W 1600LM 0-10V Dimmable

Color Preference® 3000/4000/5000K 120 80CRI TRIAC Dimmable

11" Cliff

Model # 54450311
Part # FM-11-14-802-SV-D-K
14W 910LM



15" Cliff

Model # 54451311
Part # FM-15-22-802-SV-D-K
22W 1450LM



11" Carousel

Model # 54450511
Part # FM-11-14-802-SV-D-J
14W 910LM

15" Carousel

Model # 54451511
Part # FM-15-22-802-SV-D-J
22W 1450LM



11" Falls

Model # 54450111
Part # FM-11-14-802-SV-D-L
14W 910LM



15" Glacier

Model # 54451211
Part # FM-15-22-802-SV-D-M
22W 1450LM



15" Color Preference®
with Bluetooth® Speaker

Model # 54620313
Part # FM-15-16-802-SV-D-BT
28W 1600LM

Flushmount - Single CCT

4000K - 120V - 80CRI



7" Low Profile - Non-Dimmable
Model # 54663142

Part # FM-7-11-840-SV-N-O
11.5W 810LM



11" Brushed Nickel Trim - TRIAC Dimmable
Model # 54643142

Part # FM-11-14-840-SV-D-C
14W 980LM



15" Brushed Nickel Trim - TRIAC Dimmable
Model # 54620142

Part # FM-15-22-840-SV-D-C
22W 1550LM



12" Reva Stepped Lens - TRIAC Dimmable
Model # 54074343

Part # FM-12-14-840-SV-D-E
14W 1000LM



16" Reva Stepped Lens - TRIAC Dimmable
Model # 54075343

Part # FM-16-22-840-SV-D-E
22W 1640LM



24" Reva Stepped Lens - TRIAC Dimmable
Model # 54614242

Part # FM-24-40-840-SV-D-E
40W 2900LM

12"- 120-277V



12" Low Profile, Non-Dimmable
Model # 54436201

Part # FM-12-14-827-MV-N-B
14W 980LM 2700K



12" Low Profile, Non-Dimmable
Model # 54436241

Part # FM-12-14-840-MV-N-B
14W 1000LM 4000K

16"- 120-277V



16" Low Profile, Non-Dimmable
Model # 54437201

Part # FM-16-22-827-MV-N-B
22W 1500LM 2700K



16" Low Profile, Non-Dimmable
Model # 54437241

Part # FM-16-22-840-MV-N-B
22W 1600LM 4000K

9" Decorative Brushed Nickel Spin Light® with Color Preference®

Color Select: 2700K/3000K/3500K/4000K/5000K CCT



Model # 56558101
Part # SLDC-9IN-810LM-8-CP5-SV-N-BN
11.5W 810LM 80CRI 120V



Installs in Seconds

Converts bare lamp holder into attractive LED Flushmount!



Speedmount® Accessory

Speedmount® converts your junction box into lamp holder

TRADITIONAL STYLE SPIN LIGHT® AVAILABLE IN 5", 7", & 11"



5" Spin Light®
Model # 54692142
Part # SL-5-8-840-SV-N
8.5W 600LM 4000K



7" Spin Light®
Model # 54606211
Part # SL-7-11-830-SV-N
11.5W 810LM 3000K



7" Spin Light®
Model # 54483141
Part # SL-7-83-840-SV-N
11.5W 830LM 4000K



7" Color Preference® Spin Light®
Model # 54690112
Part # SL-7-81-802-SV-N
11.5W 810LM 3000/4000/5000K



11" Spin Light®
Model # 54652141
Part # SL-11-16-840-SV-N
22W 1600LM 4000K



11" Spin Light® - Brushed Nickel
Model # 54652144
Part # SL-11-16-840-SV-N-BN
22W 1600LM 4000K

TRADITIONAL STYLE SPIN LIGHT® WITH MOTION SENSOR - AVAILABLE IN 7"



7" Spin Light® with Motion Sensor
Model # 54606342
Part # SL-7-83-840-SV-N-OS
11.5W 830LM 4000K

TRADITIONAL STYLE SPIN LIGHT® WITH PULL CHAIN CONTROL AVAILABLE IN 7"



7" Spin Light® - Pull Chain
Model # 54484141
Part # SLP-7-83-840-SV-N
11.5W 830LM 4000K

ETi Advantage

- ✓ Available in both Traditional and Decorative styles from 5" to 11"
- ✓ Color Preference® models available with selectable 3000K, 4000K, or 5000K!
- ✓ Wall switch controlled, also available in pull chain and motion sensor versions.
- ✓ 80 CRI
- ✓ 120V



Linkable, Beam Adjustable LED Under Cabinet Light

Dim2Warm™ Under Cabinet Light

Transitions from 3000K to 2200K when dimmed



MagnaMount™ Installation

MagnaMount™ mounting plate makes cabinet installation quick and easy

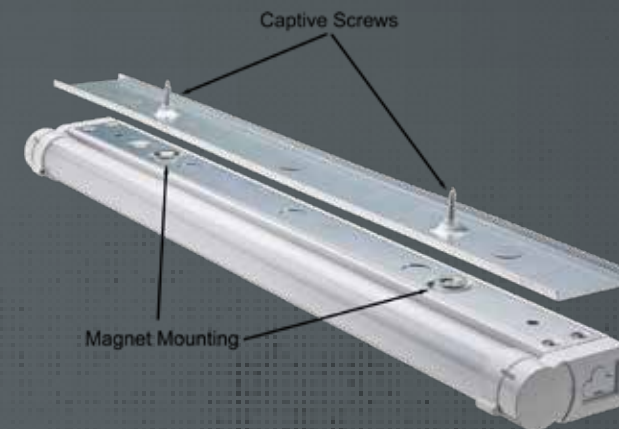

12"
Model # 53502111
Part # UC-12-5-930-SV-D
5.5W 300LM 120V 90CRI

18"
Model # 53503111
Part # UC-18-9-930-SV-D
9W 500LM 120V 90CRI

24"
Model # 53504111
Part # UC-24-12-930-SV-D
12.5W 700LM 120V 90CRI

32"
Model # 53505111
Part # UC-32-10-930-SV-D
15W 1000LM 120V 90CRI

42"
Model # 53506111
Part # UC-42-15-930-SV-D
22W 1500LM 120V 90CRI

Direct Wire or Plug in



LINKABLE UNDER CABINET LIGHT WITH STEP DIMMING SWITCH

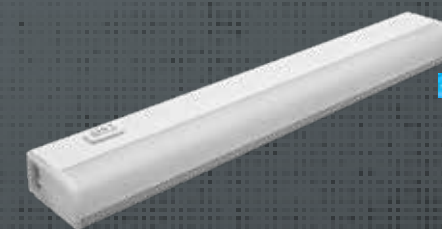

12" Linkable Under Cabinet Light with Step Dimming Switch
Model # 54196112
Part # UC-12-6-830-SV
6W 350LM 3000K 120V 80CRI



18" Linkable Under Cabinet Light with Step Dimming Switch
Model # 54195112
Part # UC-18-8-830-SV
8W 500LM 3000K 120V 80CRI



24" Linkable Under Cabinet Light with Step Dimming Switch
Model # 54194112
Part # UC-24-11-830-SV
11W 700LM 3000K 120V 80CRI



STRIP LIGHTS



VersaStrip™

The Most Versatile LED Strip Light Available!

ETi Advantage

- ✓ Future proofed! Replaceable light engine & driver
- ✓ Value priced 0-10V photo sensor available
- ✓ Tandem and parallel mounting brackets included
- ✓ Converts to 11,000 lumen controllable warehouse high bay fixture Shatterproof
- ✓ PMMA lens will not discolor over time
- ✓ Industrial grade powder coated housing
- ✓ Extra wire length included plus quick-connects for easy installation
- ✓ UL damp location rated

Multiple Ways to Install

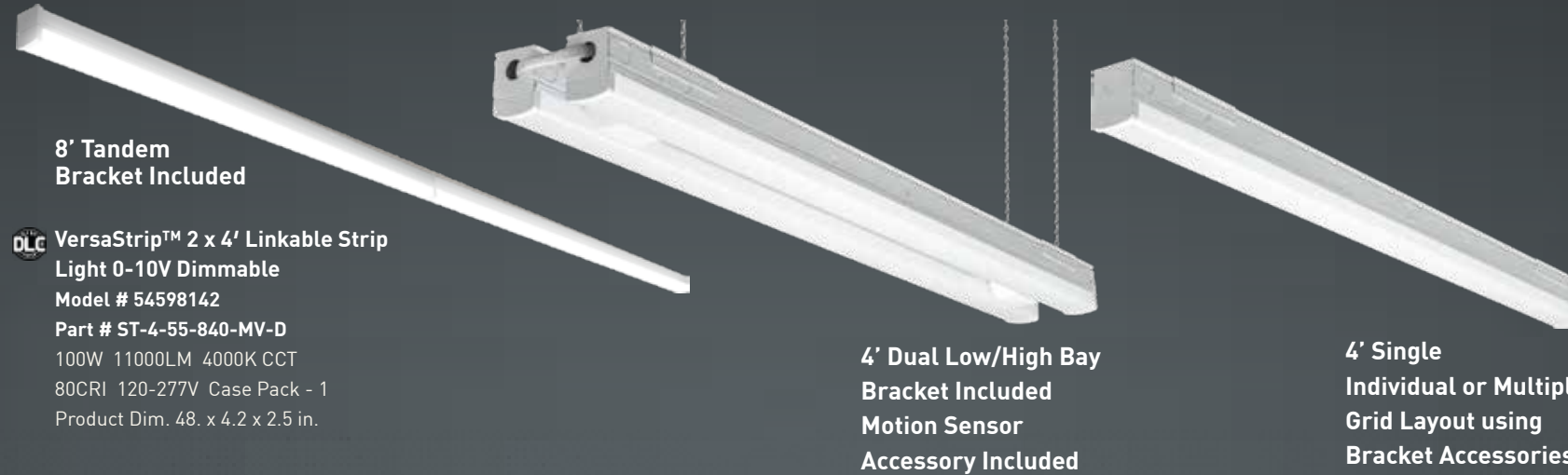

8' Tandem Bracket Included

DLC VersaStrip™ 2 x 4' Linkable Strip Light 0-10V Dimmable
 Model # 54598142
 Part # ST-4-55-840-MV-D
 100W 11000LM 4000K CCT
 80CRI 120-277V Case Pack - 1
 Product Dim. 48. x 4.2 x 2.5 in.

4' Dual Low/High Bay Bracket Included
 Motion Sensor Accessory Included

4' Single Individual or Multiple Grid Layout using Bracket Accessories

VersaStrip Accessories



Model # 90600647
 Motion Sensor

Model # 90600650
 Parallel Linking Bracket

Model # 90600648
 L Linking Bracket

Model # 90600651
 Cross Linking Bracket

Model # 90600649
 T Linking Bracket

Model # 90600652
 Adjustable Linking Bracket

LINKABLE STRIP LIGHTS



2' Linkable Strip Light, Direct Wire or Plug-In
 Model # 54263143
 Part # ST-2-9-840-SV-N
 8.5W 900LM 4000K CCT
 80CRI 120V Case Pack - 6
 Product Dim. 24 x 1.6 x 2.3 in.



4' Linkable Strip Light, Direct Wire or Plug-In
 Model # 54261143
 Part # ST-4-18-840-SV-N
 17W 1800LM 4000K CCT
 80CRI 120V Case Pack - 4
 Product Dim. 48 x 1.6 x 2.3 in.

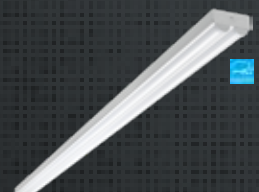

8' Linkable Strip Light (ENERGY STAR®)
 Model # 54599142
 Part # ST-8-90-840-SV-N
 90W 9000LM 5000K CCT
 80CRI 120V Case Pack - 2
 Product Dim. 95.5 x 4.1 x 2.4 in.

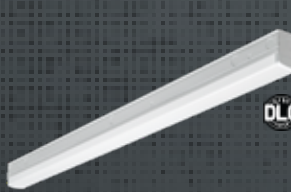

4' Linkable High Lumen Output Strip Light - 0-10V Dimmable
 Model # 54573161
 Part # ST-4-45-850-MV-D
 45W 5000LM 5000K CCT
 80CRI 120-277V Case Pack - 6
 Product Dim. 48 x 1.8 x 2.2 in.

NON-LINKABLE STRIP LIGHTS



2' Strip Light, Direct Wire
 Model # 54260144
 Part # ST-2-18-840-MV-N
 17W 1800LM 4000K CCT
 80CRI 120-277V Case Pack - 6
 Product Dim. 24 x 2.2 x 2.7 in.



4' Strip Light, Direct Wire
 Model # 54283144
 Part # ST-4-36-840-MV-N
 34W 3600LM 4000K CCT
 80CRI 120-277V Case Pack - 4
 Product Dim. 48 x 2.2 x 2.7 in.



4' High Lumen Output Strip Light, Compatible with Battery Back-Up
 Model # 54583361
 Part # ST-4-33-850-MV-N-EM
 33W 4900LM 5000K CCT
 80CRI 120-277V Case Pack - 6
 Product Dim. 48 x 1.8 x 2.2 in.

STRIP LIGHT ACCESSORIES

Model #	Description	Compatible Model #
90600737	Strip Light Accessory - Continuous Linking Bracket	54263143 and 54261143
90600738	Strip Light Accessory - Tandem Linking Bracket	54263143 and 54261143
90600739	Strip Light Accessory - Plastic Cover	54598142
70101101	Universal wattage BBU for Non-isolated Driver	54573161 and 54583361
90600121	Motion Sensor (External)	All Models

WRAP LIGHTS



48" Commercial Wrap Light - 0-10V Dimmable

Model # 56514142 | Part # WR-4-43-840-MV-D
 39W 4300LM 4000K CCT 120-277V
 80CRI 120-277V Case Pack - 2
 Product Dimensions 48 x 7.4 x 2.7 in.



48" Commercial Wrap Light

- Captive hinge frees up both hands for easy wiring
- Snap-in wire connectors make power connection a breeze
- Tandem connect up to 10 fixtures
- Compatible with step-dimming motion sensor
- Easy to install

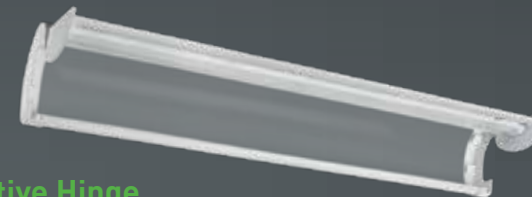

Captive Hinge



ROBUST, IMPACT RESISTANT LENS

EZ WRAP LIGHT
INSTALL

WRAP LIGHTS

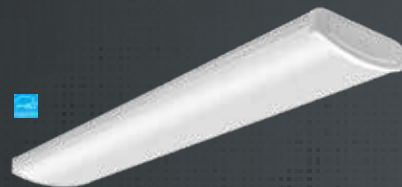

High Lumen

4' High Lumen Output Wrap 0-10V Dimmable (ENERGY STAR®)
 Model # 54677441
 Part # WR-4-57-940-MV-D
 57W 5200LM 4000K CCT 90CRI 120-277V
 Case Pack - 2
 Product Dim. 48 x 10 x 3.1 in.



Compact

4' Compact Wrap Light
 Model # 56513141
 Part # WR-4-36-840-MV
 40W 3600LM 4000K CCT 80CRI 120-277V
 Case Pack - 6
 Product Dim. 48 x 5 x 1.8 in.



Motion Sensor

4' Wrap Light with Motion Sensor (ENERGY STAR®)
 Model # 54676142
 Part # WR-4-40-940-SV-N-OS
 40W 3600LM 4000K CCT 90CRI 120V
 Case Pack - 2
 Product Dim. 48 x 5.9 x 2.9 in.



2' Wrap

2' Wrap Light - 0-10V Dimmable (ENERGY STAR®)
 Model # 54655441
 Part # WR-2-20-940-MV-D
 20W 1800LM 4000K CCT
 90CRI 120-277V Case Pack - 4
 Product Dim. 23.6 x 5.9 x 2.9 in.

4' Wrap

4' Wrap - 0-10V Dimmable
 Model # 54676241
 Part # WR-4-36-940-MV-D
 34W 3600LM 4000K CCT
 90CRI 120-277V Case Pack - 2
 Product Dim. 48 x 5.9 x 2.9 in.

DLC 4' Wrap with Step Dimming Motion Sensor
 Model # 54676241-I
 Part # WR-4-36-940-MV-D-OS
 34W 3600LM 4000K CCT
 90CRI 120-277V Case Pack - 2
 Product Dim. 48 x 5.9 x 2.9 in.

4' Wrap - Battery Backup

4' Wrap with Battery Back-Up
 Model # 54676341
 Part # WR-4-36-940-MV-D-EM
 34W 3600LM 4000K CCT
 90CRI 120-277V Case Pack - 2
 Product Dim. 48 x 5.9 x 2.9 in.

DLC 4' Wrap with Battery Back-Up and Step Dimming Motion Sensor
 Model # 54676341-I
 Part # WR-4-36-940-MV-D-EM-OS
 34W 3600LM 4000K CCT
 90CRI 120-277V Case Pack - 2
 Product Dim. 48 x 5.9 x 2.9 in.



Color Preference®

40" Color Preference® Wrap Light - TRIAC Dimmable (ENERGY STAR®)
 Model # 56507113
 Part # WR-40-26-802-SV-D
 30W 2600LM 3000/4000/5000K CCT 80CRI 120V
 Case Pack - 2
 Product Dim. 39.9 x 4 x 2 in.



Closet Lighting

18" Closet Light with Pull Chain (ENERGY STAR®)
 Model # 53603142
 Part # CS-18-12-840-SV
 16W 1200LM 4000K CCT
 80CRI 120V Case Pack - 2
 Product Dim. 18 x 4.3 x 2 in.

WRAP LIGHT ACCESSORIES

Model #	Description	Compatible Model #
90600144	Step Dimming Motion Sensor	54676241 and 54676341
90600145	Motion Sensor	All Models
90600143	Battery Back-up	All Models

FLAT PANELS



CEILING LIGHTS & SHOP/TASK LIGHTS



ECO Series Flat Panels

ETI's patented Color Preference® technology allows the installer to select the desired color temperature with the flip of a switch!

ETi Advantage

- ✓ DLC Standard – high efficacy 110 LPW
- ✓ Robust, lightweight construction
- ✓ Non-yellowing, UV-resistant lens
- ✓ Excellent aesthetics at an affordable cost
- ✓ Perfect for new construction or retrofit projects
- ✓ Even edge to edge light distribution
- ✓ Office, medical, and educational facilities
- ✓ Optional BBU available

3 INSTALLATION OPTIONS
Grid Ceiling/Suspension Mounting/Surface Mounting

Reva Stepped and Traditional Lenses Available



1' x 2' Reva Stepped Lens
Model # 54648142
Part # CL-12-20-840-SV-D-G
20W 1500LM 4000K 120V 80CRI

1' x 4' Reva Stepped Lens
Model # 54647142
Part # CL-14-40-840-SV-D-G
40W 3000LM 4000K 120V 80CRI

1' x 4' Traditional Lens
Model # 54644142
Part # CL-14-40-840-SV-D-H
40W 3000LM 4000K 120V 80CRI

1.5' x 4' Traditional Lens
Model # 54645142
Part # CL-14-75-840-SV-D-H
75W 5500LM 4000K 120V 80CRI

1.5' x 4' Reva Stepped Lens
Model # 54649142
Part # CL-14-75-840-SV-D-G
75W 5500LM 4000K 120V 80CRI

ETi Advantage

- ✓ High impact Diffuser Lens
- ✓ Thin profile
- ✓ TRIAC Dimmable

Installation Benefits

- Compact Recessed Driver box
- Easy Handling
- Ultra thin backlit design
- Easy-to-install replacement for lay-in troffers, baskets, and parabolic fixtures
- Pre-installed BBU Bracket
- Multiple conduit points allows multiple accessory installation options
- Earthquake Clips already installed

2x2 Color Preference® ECO Flat Panel



Model # 64204301
Part # FPCP-2x2-3300LM-8-CP3-MV-LVD
30W 3300LM 3500K/4000K/5000KCCT
80CRI 100-277V Case Pack - 2
Product Dimensions 23.78 x 23.78 x 1.38 in.

2x4 Color Preference® ECO Flat Panel



Model # 64205401
Part # FPCP-2x4-4950LM-8-CP3-MV-LVD
45W 4950LM 3500K/4000K/5000K CCT
80CRI 100-277V Case Pack - 2
Product Dimensions 23.78 x 23.78 x 1.38 in.

FLAT PANEL ACCESSORIES

Model #	Description	Compatible Model #
90600019	Earthquake Clip Kit (10-pack, 4 clips/pk)	All Models
95457326101	Aircraft Cable for Suspension Mounting	All Models
70302105	2x2' Surface Mounting Kit for Flat Panels	64204301
70302106	2x4' Surface Mounting Kit for Flat Panels	64205401
TBD	Battery Back-up for Flat Panels	All Models

SHOP LIGHTS

4000K - 120V - 80CRI

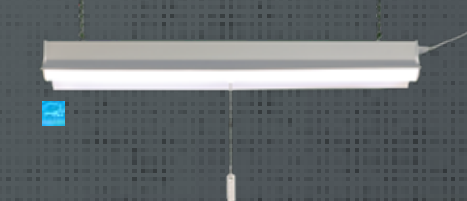

2' Linkable Shop Light
Model # 54568143
Part # SH-2-18-840-SV
18W 1600LM
Suspension Mounting Accessories and Power Linking Cable Included

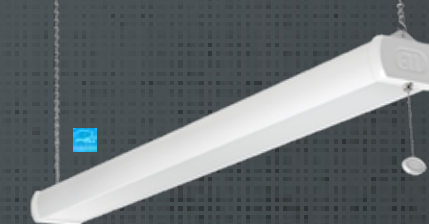

3' Slim Shop Light
Model # 54254142
Part # SH-3-42-840-SV
42W 3200LM



40" Shop Light with Bluetooth Speaker
Model # 54569143
Part # SH-40-50-840-SV-BT
50W 3500LM



4' Linkable Shop Light
Model # 54103162
Part # SH-4-35-840-SV
35W 3200LM
Suspension Mounting Accessories and Power Linking Cable Included

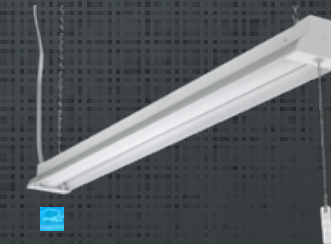

40" Shop Light
Model # 54590141
Part # SH-40-30-840-SV
30W 2800LM

ETi Advantage

- ✓ Commercial strength material lighting for those tough jobs
- ✓ 4000K CCT 80CRI 120V

External Motion Sensor (90600121)
Compatible with all models

HIGH BAY



Circular High Bay

ETi's Round High Bays can light up Warehouses, Gymnasium, and other larger spaces while saving energy!

115W Round High Bay, 0-10V Dimmable, Compatible with Motion Sensor, IP65, Wet Rated
Model # 50228661
Part # HB-115-850-MV-D
115W 15000LM 5000K 120-277V 80CRI



Motion sensor option
BBU Options - preinstalled
BBU and Field Installed

ETi Advantage

- ✓ Available in 115W, 185W, & 270W
- ✓ Replaces up to 1000W HID
- ✓ Robust, durable design
- ✓ Wet or Damp Rated
- ✓ 0-10V dimmable
- ✓ Downrod, Yoke and Hook installation methods
- ✓ Protective waterproof cover

Linear High Bays



2' Linear High Bay - 0-10V Dimmable DLC Damp Rated
Model # 50240261 | Part # HBL-2FT-18000LM-80-50K-MV-LVD
138W 18000LM 5000K 120-277V 80CRI

ETi Advantage

- ✓ EZ Install by suspension, pendant or surface mount - Brackets included
- ✓ Pendant/Flush mount Bracket enables wiring without physically supporting fixture
- ✓ Tandem brackets available for longer linear runs
- ✓ Shatter resistant PC lens built with low glare diffuser to reduce risk of forklift injuries



ROUND HIGH BAY

115W



115W Round High Bay, Compatible with Motion Sensor Accessory, Damp Rated
Model # 50228461
Part # HB-115-850-MV
115W 15000LM 5000K 120-277V 80CRI

185W



185W Round High Bay, 0-10V Dimmable, Compatible with Motion Sensor, IP65, Wet Rated
Model # 50228761
Part # HB-185-850-MV-D
185W 24000LM 5000K 120-277V 80CRI

270W



270W Round High Bay, Compatible with Motion Sensor Accessory, Damp Rated
Model # 50228561
Part # HB-270-850-MV
270W 38000LM 5000K 120-277V 80CRI



115W Round High Bay, Compatible with BBU and Motion Sensor, Damp Rated
Model # 50228261
Part # HB-115-850-MV-EM
115W 15000LM 5000K 120-277V 80CRI



270W Round High Bay, 0-10V Dimmable, Compatible with Motion Sensor, IP65, Wet Rated
Model # 50228861
Part # HB-270-850-MV-D
270W 38000LM 5000K 120-277V 80CRI

92W 12000LM	138W 18000LM	180W 24000LM
Replaces 250-400W HID	Replaces 400W HID	Replaces >400W HID

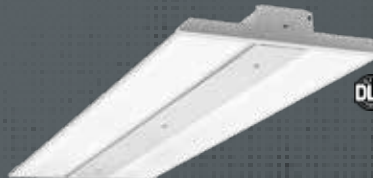

2' Linear High Bay - 0-10V Dimmable DLC Damp Rated
Model # 50240161
Part # HBL-2FT-12000LM-80-50K-MV-LVD
92W 12000LM 5000K 120-277V 80CRI

2.75' Linear High Bay - 0-10V Dimmable DLC Damp Rated
Model # 50241161
Part # HBL-2.75FT-24000LM-80-50K-MV-LVD
180W 24000LM 5000K 120-277V 80CRI

PREMIUM LINEAR HIGH BAY WITH TEMPERED GLASS LENS



2' Linear High Bay, 0-10V Dimmable Damp Rated
Model # 50232162
Part # HB-171-850-MV-D
171W 18000LM 5000K 120-277V 80CRI

NEW ACCESSORIES AVAILABLE FOR PURCHASE:

Mounting Bracket
Model # 95024016101/95024016103

Mounting Plate Cover
Model # 95024016101/95024016103

1/2" Downrod Mount/7mm Threaded Downrod Mount
Model # 95024016103

Tandem Mounting Bracket
Model # 95024016102



HIGH BAY ACCESSORIES

Model #	Description	Compatible Model #
70112201	Battery Back-up	50228461, 50228661, 50228761, 50228561, 50228861
90600121	Motion Sensor (External)	50228461, 50228261, 50228361
70201101	Step Dimming Motion Sensor (External)	50228661, 50228761, 50228861
95457326101	Aircraft Cable for Suspension Mounting (Two 10' pieces)	All Models
90600143	Battery Back-up	50228261

VAPOR TIGHTS

Vapor Tights

- Wide 110° beam angle
- 120-227V
- >80CRI
- 0-10V dimmable (51W and 56W)
- Temp rating -4°F-113°F
- L70 >50,000
- 5 Year limited warranty



ETi Advantage

- ✓ Durable stainless-steel latches
- ✓ Captive hinged lens makes for quick and EZ Installation
- ✓ Suspended or ceiling mount installation, Brackets included!
- ✓ Replaceable light engines and drivers
- ✓ NSF Rated
- ✓ Upgrade options include integrated microwave motion sensor and BBU (Battery Backup Unit)

STANDARD LUMEN

3600LM 4000K 120-277V 80CRI

Base **4' 34W Vapor Tight (NSF)**
Model # 54656241
Part # VT-4-34-840-MV 34W

Motion Sensor **4' Tight with Motion Sensor 34W Vapor (NSF)**
Model # 54656241-I
Part # VT-4-34-840-MV-OS 34W

BBU **4' 40W Vapor Tight with Battery Back-Up (NSF)**
Model # 54656341
Part # VT-4-40-840-MV-EM 40W

Motion Sensor & BBU **4' 40W Vapor Tight with Battery Back-Up and Motion Sensor (NSF)**
Model # 54656341-I
Part # VT-4-40-840-MV-EM-OS 40W

MID LUMEN

51W 5400LM 120-277V 80CRI

Base **4' 51W Vapor Tight - 0-10V Dimmable (NSF)**
Model # 54465141
Part # VT-4-54-840-MV-D
4000K CCT

Base **4' 51W Vapor Tight - 0-10V Dimmable (NSF)**
Model # 54465141
Part # VT-4-54-850-MV-D
5000K CCT

Motion Sensor **4' 51W Vapor Tight with Motion Sensor - 0-10V Dimmable (NSF)**
Model # 54465141-I
Part # VT-4-54-840-MV-D-OS
4000K CCT

HIGH LUMEN

56W 7000 LM 120-277V 80CRI

4' 56W High Lumen Output Vapor Tight - 0-10V Dimmable
Model # 64501141
Part # VT-4-70-840-MV-D
4000K CCT

4' 56W High Lumen Output Vapor Tight - 0-10V Dimmable
Model # 64501141
Part # VT-4-70-850-MV-D
5000K CCT

VAPOR TIGHT ACCESSORIES

Model #	Description	Compatible Model #
95457326101	Aircraft Cable for Suspension Mounting (Two 10' pieces)	All Models
90600145	Motion Sensor (Internal)	54656241-I, 54656341-I
90600143	Battery Back-up	54656341, 54656341-I
90600144	Step Dimming Motion Sensor (Internal)	54465141-I, 64501141, 64501161

LED TUBE READY FIXTURES

Tube Ready Fixtures

T8 & T5 Type B Power Either End & Single End Power

T5
4' Linear 6-lamp T5 Type B Single End Power High Bay Fixture Body
Model # 70301113
Part # HBH-4-6-T5-S

T8
4' Linear 6-lamp T8 Type B Power Either End High Bay Fixture Body
Model # 70301114
Part # HBH-4-6-T8-E



4' Linear 6-lamp T5 Type B Single End

4' & 6' LINEAR 4-LAMP HIGH BAY FIXTURE BODY



T5
4' Linear 4-lamp T5 Type B Single End Power High Bay Fixture Body
Model # 70302112
Part # HBH-4-4-T5-S

T8
4' Linear 4-lamp T8 Type B Power Either End High Bay Fixture Body
Model # 70302111
Part # HBH-4-4-T8-E

T8 & T5 Type B Power Either End & Single End Power

4 LAMP SINGLE END T8

Double Batten 8' Tube Ready Fixture



T8
Double Batten 8' Tube Ready Fixture - 4 Lamp Single End T8
Model # 64401101
Part # TRDB-4FT-T8-4L-SE



OUTDOOR LIGHTING

AREA LIGHTS & SECURITY LIGHTS



SPORTS LIGHTING



High Lumen Area Light



High Lumen Output Area Light
Model # 53302261
Part # AL-90-850-MV
 80W 9000LM 5000K CCT 120-277V 80CRI

ETi Advantage

- ✓ Photocell Motion Sensor in all models



Color Preference® Area Light

40W 3500LM 3000K/4000K/5000K CCT 120V 80CRI



Model # 53301111
Part # AL-40-802-SV-N-BZ



Model # 53301112
Part # AL-40-802-SV-N-W

SECURITY LIGHTS



2-Head Dusk to Dawn Security Light (White)
Model # 51401144
Part # SC-20-840-SV-W
 20W 1200LM 4000K CCT 80CRI 120V

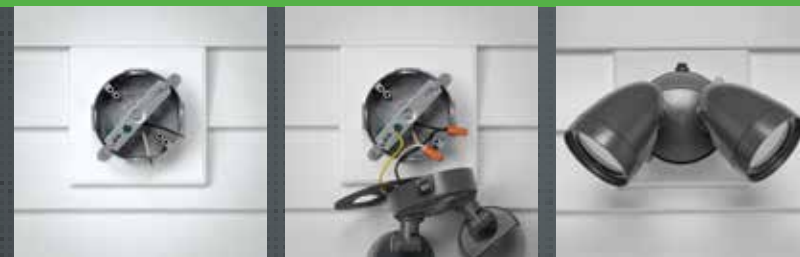

2-Head Dusk to Dawn Security Light (Bronze)
Model # 51401142
Part # SC-20-840-SV-BZ
 20W 1200LM 4000K CCT 80CRI 120V

2-HEAD DUSK TO DAWN INSTALLATION WITH MOTION SENSOR



2-Head Dusk to Dawn Security Light with Motion Sensor (Bronze)
Model # 51402241
Part # SC-20-840-SV-0S-BZ
 20W 1800LM 4000K CCT 80CRI 120V



2-Head Dusk to Dawn Security Light with Motion Sensor (White)
Model # 51402242
Part # SC-20-840-SV-0S-W
 20W 1800LM 4000K CCT 80CRI 120V

High Performance Sports Lighting



400W 52,000LM 120-277V

30° Beam Model # 60502261 Part # SLTR-400W-52KLM-7-50K-MV-30D
40° Beam Model # 60505261 Part # SLTR-400W-52KLM-7-50K-MV-40DD
120° Beam Model # 60504261 Part # SLTR-400W-52KLM-7-50K-MV-120D
 Also 30°, 40° & 120° models with 277-480V available:
 60502661, 60505661, 60504661



600W 78,000LM 120-277V

15° Beam Model # 60501361 Part # SLTR-600W-78KLM-7-50K-MV-15D
40° Beam Model # 60505361 Part # SLTR-600W-78KLM-7-50K-MV-40D
 Also 15° & 40° models with 277-480V available:
 60501761, 60505761



1000W 130,000LM 120-277V

12° Beam Model # 60511461 Part # SLTR-1000W-130KLM-7-50K-MV-12D
30° Beam Model # 60502461 Part # SLTR-1000W-130KLM-7-50K-MV-30D
45° Beam Model # 60506461 Part # SLTR-1000W-130KLM-7-50K-MV-45D
60° Beam Model # 60503461 Part # SLTR-1000W-130KLM-7-50K-MV-60D
 Also 12°, 30°, 45° & 60° models with 277-480V available:
 60511861, 60502861, 60506861, 60503861



1200W 156,000LM 120-277V

12° Beam Model # 60511561 Part # SLTR-1200W-156KLM-7-50K-MV-15D
30° Beam Model # 60502561 Part # SLTR-1200W-156KLM-7-50K-MV-30D
40° Beam Model # 60505561 Part # SLTR-1200W-156KLM-7-50K-MV-40D
60° Beam Model # 60503561 Part # SLTR-1200W-156KLM-7-50K-MV-60D
 Also 12°, 30°, 40° & 60° models with 277-480V available:
 60511961, 60502961, 60505961, 60503961



400W – 52,000LM
 600W – 78,000LM
 1000W – 130,000LM
 1200W – 156,000LM

All models include yoke mounting bracket
 5000K CCT 70CRI

ETi Advantage

- ✓ 7 Beam angle options (options depending on model)
- ✓ Cold forged heat sink for superior heat management
- ✓ IP65 waterproof rating
- ✓ 6KV integrated surge (20KV optional)
- ✓ Powder coated finish with proprietary anti-corrosion primer
- ✓ Optional laser alignment tool

Accessory options include glare hood, slip fitter bracket, and HD surge arrester.

Glare Hood 400W
 Model # 70701101
Glare Hood 600W
 Model # 70701102
Glare Hood 1000-1200W
 Model # 70701103

Slip Fitter Bracket 400W
 Model # 70301301
Slip Fitter Bracket 600W-1000W-1200W
 Model # 70301401

Surge Protection 400W
 Model # 70801101
Surge 600W-1000W-1200W
 Model # 70801102

Laser
 Model # 70901101

WALL PACKS



OUTDOOR LIGHTING

SHOREBREAKER LIGHTING® & OUTDOOR FLUSHMOUNTS



Traditional



Full Cut-Off

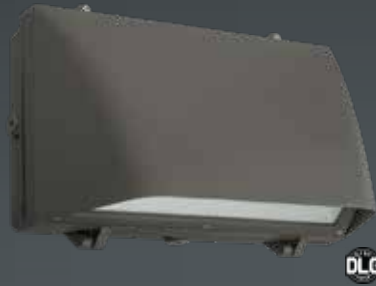

DUSK TO DAWN WALL PACK



Traditional Dusk to Dawn Wall Pack
Model # 53305161 | Part # WP-18-850-MV 18W 1800LM

TRADITIONAL WALL PACK, PHOTOCELL COMPATIBLE



14" Wall Pack
Model # 53304261 | Part # WP-32-850-MV 32W 3500LM



14" Wall Pack
Model # 53304161 | Part # WP-54-850-MV 54W 6000LM



14" Wall Pack
Model # 53304361 | Part # WP-74-850-MV 74W 8000LM



18" Wall Pack
Model # 53303161 | Part # WP-90-850-MV 90W 10,000LM

FULL CUT-OFF WALL PACK, PHOTOCELL COMPATIBLE



Model # 53307361 | Part # WP-26-850-MV 20W 2600LM



Model # 53307261 | Part # WP-39-850-MV 30W 3900LM



Model # 53307161 | Part # WP-78-850-MV 60W 7800LM



Model # 53308261 | Part # WP-97-850-MV 75W 9750LM



Model # 53308161 | Part # WP-130-850-MV 100W 13,000LM

ETi Advantage

- ✓ Tough die case aluminum constructions
- ✓ Photocell compatible
- ✓ IP65 weather rating
- ✓ Traditional and Full Cut-off models
- ✓ Cut-off Light Shield available for Traditional Wall Pack Series

Features & Specifications

Wide 110° beam angle • 120-277V • 80CRI
Temp rating -4°F -113 °F • L70 >50,000 • 5000K CCT

WALL PACK ACCESSORIES

Model #	Description	Compatible Model #
20170001	Photocell for Wall Pack	53304261, 53304161, 53304361, 53303161
90600231	Cut Off Shield for 14" Wall Pack	53304261, 53304161, 53304361
90600232	Cut Off Shield for 18" Wall Pack	53303161

Weather Tough Outdoor Lighting



ETi Advantage

- ✓ IP65 Rated for coastal installations
- ✓ 3 CCT Color Preference® technology*
- ✓ 10" round or 10" x 6" oval styles
- ✓ Optional decorative/ functional lens shields
- ✓ Commercial/residential voltage - 120-277V
- ✓ 12.W - 1100LM - 3000K/4000K/5000K CCT or 9W - 800LM - 3000K CCT
- ✓ Longer 60,000 LED life
- ✓ 80CRI



10" Round Black
Model # 50403112 - 3 CCT
Part # COL-11-802-MV-R-B
Model # 50405112
Part # COL-8-830-MV-R-B



10" Round White
Model # 50403111 - 3 CCT
Part # COL-11-802-MV-R-W
Model # 50405111
Part # COL-8-830-MV-R-W



10" x 6" Oval Black
Model # 50402112 - 3 CCT
Part # COL-11-802-MV-O-B
Model # 50404112
Part # COL-8-830-MV-O-B



10" x 6" Oval White
Model # 50402111 - 3 CCT
Part # COL-11-802-MV-O-W
Model # 50404111
Part # COL-8-830-MV-O-W

ACCESSORIES AVAILABLE IN BLACK FINISH OR WHITE FINISH

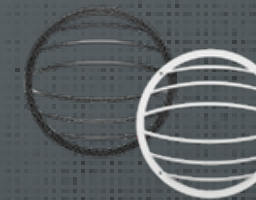

Model # 90600501 Black
90600502 White

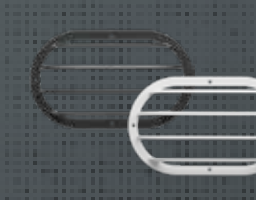

Model # 90600503 Black
90600504 White



Model # 90600505 Black
90600506 White



Model # 90600507 Black
90600508 White

Impact and corrosion resistant housing
Suitable for ceiling or wall mount

Replaces 60-75W incandescent fixture
3 CCT options: 3000K, 4000K, or 5000K

OUTDOOR FLUSHMOUNTS



Color Preference® Flushmount (Black)
Model # 54466101
Part # FME-83-802-MV-N-N-B
12.5W 830LM 3000/4000/5000K CCT 80 CRI 120-277V



Color Preference® Flushmount (White)
Model # 54466201
Part # FME-83-802-MV-N-N-W
12.5W 830LM 3000/4000/5000K CCT 80 CRI 120-277V

HID Replacement Lamps

CR SERIES

HID REPLACEMENT LAMPS



PT SERIES

HID REPLACEMENT LAMPS



360° Omni-Directional Retrofit

Upgrade to LED but keep existing, historically significant light fixtures!

ETi Advantage

- ✓ Replaces HID Lamps from 70w to 400w
- ✓ Up to 150 LPW efficacy
- ✓ IP64 moisture rating
- ✓ Intelligent thermal protection for superior enclosed fixture performance
- ✓ Integrated 6kV surge protection
- ✓ DLC APPROVED (EX39 ONLY)
- ✓ 5 Year warranty, L70 >50,000 HRS

120-277V Multi-Volt 80 CRI



Directional Post Top Retrofit

Angled LEDs deliver more light to sidewalk and street surfaces.

ETi Advantage

- ✓ Replaces HID Lamps from 150w to 50w
- ✓ Up to 150 LPW efficacy
- ✓ IP64 moisture rating
- ✓ Intelligent thermal protection for superior enclosed fixture performance
- ✓ Integrated 6kV surge protection
- ✓ DLC APPROVED (EX39 ONLY)
- ✓ 5 Year warranty, L70 >50,000 HRS

120-277V Multi-Volt 80 CRI



Angled LED Array

Delivers brighter lighting to walkways, grassy areas and roads when used in decorative post tops

Convertible for "base-up" or "base-down" installations



Great Retrofit Solution for Decorative Post Top and Bollard Fixtures

Great Retrofit Solution for Decorative Post Top and Bollard Fixtures

CR SERIES HID REPLACEMENTS LAMPS

PT SERIES HID REPLACEMENTS LAMPS

15W Repl. 70W E26 Base	27W Repl. 150W E26 Base	54W Repl. 175W EX39 Base
 <p>Model # 62701111 Part # CR-15-830-MV 2025LM 3000K CCT</p>	 <p>Model # 62702111 Part # CR-27-830-MV 3645LM 3000K CCT</p>	 <p>Model # 62703111 Part # CR-54-830-MV 7290LM 3000K CCT</p>
 <p>Model # 62701141 Part # CR-15-840-MV 2250LM 4000K CCT</p>	 <p>Model # 62702141 Part # CR-27-840-MV 4050LM 4000K CCT</p>	 <p>Model # 62703141 Part # CR-54-840-MV 8100LM 4000K CCT</p>
 <p>Model # 62701161 Part # CR-15-850-MV 2250LM 5000K CCT</p>	 <p>Model # 62702161 Part # CR-27-850-MV 4050LM 5000K CCT</p>	 <p>Model # 62703161 Part # CR-54-850-MV 8100LM 5000K CCT</p>
80W Repl. 250W EX39 Base	100W Repl. 400W EX39 Base	125W Repl. >400W EX39 Base
 <p>Model # 62704111 Part # CR-80-830-MV 10,800LM 3000K CCT</p>	 <p>Model # 62705111 Part # CR-100-830-MV 13,500LM 3000K CCT</p>	 <p>Model # 62706111 Part # CR-125-830-MV 16,875LM 3000K CCT</p>
 <p>Model # 62704141 Part # CR-80-840-MV 12,000LM 4000K CCT</p>	 <p>Model # 62705141 Part # CR-100-840-MV 15,000LM 4000K CCT</p>	 <p>Model # 62706141 Part # CR-125-840-MV 18,750LM 4000K CCT</p>
 <p>Model # 62704161 Part # CR-80-850-MV 12,000LM 5000K CCT</p>	 <p>Model # 62705161 Part # CR-100-850-MV 15,000LM 5000K CCT</p>	 <p>Model # 62706161 Part # CR-125-850-MV 18,750LM 5000K CCT</p>

30W Repl. 150W EX39 Base	50W Repl. 175W EX39 Base	80W Repl. 250W EX39 Base
 <p>Model # 62707111 Part # PT-30-830-MV 3900LM 3000K CCT</p>	 <p>Model # 62707211 Part # PT-50-830-MV 6500LM 3000K CCT</p>	 <p>Model # 62708111 Part # PT-80-830-MV 10,400LM 3000K CCT</p>
 <p>Model # 62707141 Part # PT-30-840-MV 3900LM 4000K CCT</p>	 <p>Model # 62707241 Part # PT-50-840-MV 6500LM 4000K CCT</p>	 <p>Model # 62708141 Part # PT-80-840-MV 10,400LM 4000K CCT</p>
 <p>Model # 62707161 Part # PT-30-850-MV 3900LM 5000K CCT</p>	 <p>Model # 62707261 Part # PT-50-850-MV 6500LM 5000K CCT</p>	 <p>Model # 62708161 Part # PT-80-850-MV 10,400LM 5000K CCT</p>

Superior Optical Performance & Electronic Design
Intelligent thermal protection for superior enclosed fixture performance.

Robust, Durable Construction

- IP64 rated housing superior when installed in leaky fixtures.
- EX39 base version

BALLAST BYPASS LED GLASS TUBES

DOUBLE END POWER

EZ Install Bypass Ballast Retrofit

Double-End Power. T8 & T5 Retrofits up to 150 LPW.

ETi Advantage

- ✓ EZ Install “double end power” design
- ✓ No need to replace shunted sockets
- ✓ Simple ballast bypass rewiring
- ✓ Available in standard and shatter resistant glass
- ✓ Complete linear LED solution 4’ T8, 8’ T8 and 4’ T5 retrofits
- ✓ Ultra low T8 12w LED delivers payback in less than 6 months!
- ✓ Get 15-25% greater energy savings versus typical 14w-16w T8 retrofits
- ✓ 45% lower installation costs* versus single end power Type B retrofits

*(\$8/tube for EZ install vs. \$15/tube for Type B single end)



BALLAST BYPASS LED GLASS TUBES

DOUBLE END POWER

T8 Power Double End Power Integral Driver Shatter Resistant Glass Tube

No need to replace sockets. Can be used with either shunted or non-shunted sockets.

Never worry about ballasts again!

- Ballasts will fail! Avoid future ballast failures that are often seen after installing Type A (ballast compatible) retrofits lamps.
- No “ballast compatibility” issues especially with “multi-lamp per ballast troffers.”
- No ballast noise and eliminate ballast power consumption.

4’ T8

Model # 64101163
Part # T8BP-4-12-850-MV-DE-PET
12W 1800LM 5000K CCT

4’ T8

Model # 64101143
Part # T8BP-4-12-840-MV-DE-PET
12W 1800LM 4000K CCT



T8 DOUBLE END POWER GLASS TUBE

T5 DOUBLE END POWER GLASS TUBE



4’ T8 Double End Power Integral Driver Glass Tube

Model # 64101141
Part # T8BP-4-12-840-MV-DE
12W 1800LM 4000K CCT

Model # 64101161
Part # T8BP-4-12-850-MV-DE
12W 1800LM 5000K CCT

8’ T8 Double End Power Integral Driver Glass Tube

Model # 64102161
Part # T8BP-8-55-850-MV-DE
43W 5500LM 5000K CCT



4’ T5 Double End Power Integral Driver Glass Tube

Model # 64105161
Part # T5BP-4-35-850-MV-DE
25W 3500LM 3500K CCT

120-277V 80CRI



LED RETROFIT KIT FOR FLUORESCENT FIXTURES

Retrofit existing 2 lamp 8’ fluorescent fixture to four 4’ lamp configuration with significantly more efficient T8/T5 linear replacement lamps.

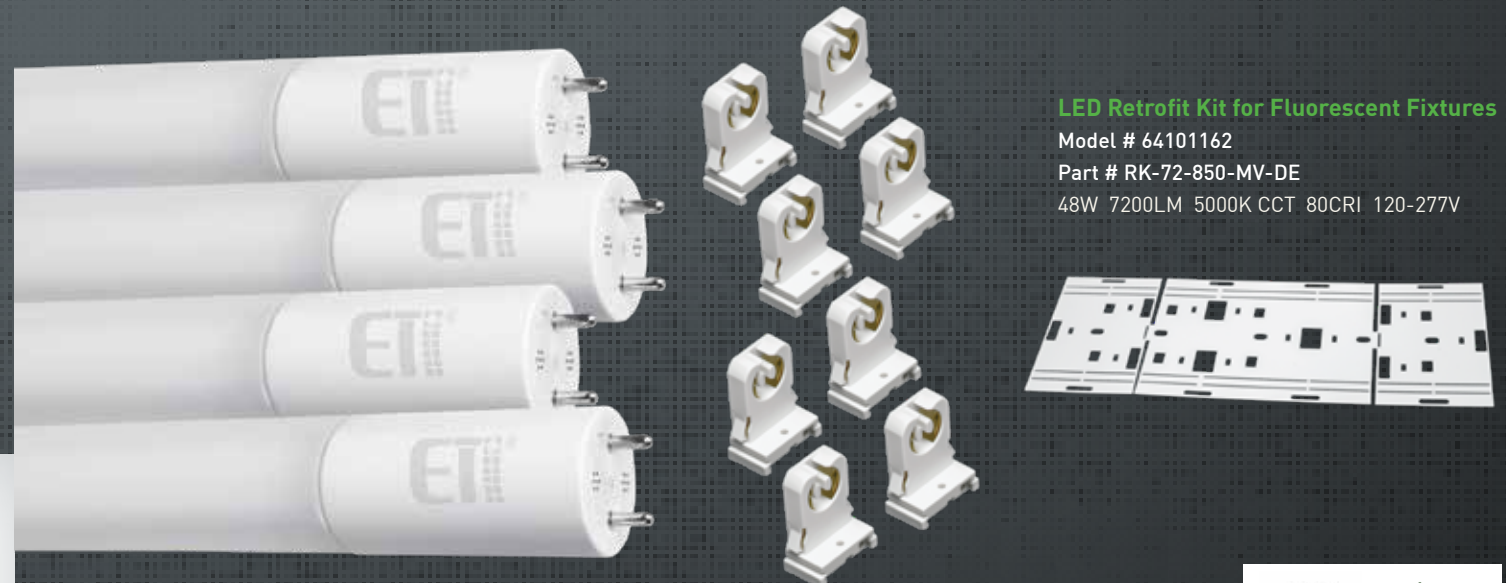

LED Retrofit Kit for Fluorescent Fixtures

Model # 64101162
Part # RK-72-850-MV-DE
48W 7200LM 5000K CCT 80CRI 120-277V

TUBE ACCESSORIES

Model #	Description	Compatible Model #
70111101	Universal wattage BBU for tube	All 4’ Models



EMERGENCY LIGHTS



EXIT SIGNS



Available with Remote Compatibility



Emergency Lights
Single Head and Double Head Products

Emergency Light Exit Sign Combo with Remote Compatibility



FEATURES & SPECIFICATIONS

- Battery backup type - Lithium Ion
- Battery operating time - >90 minutes
- Recharge time - 24 hours
- Temp rating - 32°F -104 °F L70 >50,000
- Warranty - 5 Year Limited

Remote Compatibility



**Emergency Light with
Remote Compatibility (2-head)**
Model # 55501201 Part # EM-EL-RC
2.4W 249LM 6500K CCT 120-277V

Base Model



Emergency Light (2-head)
Model # 55501101 Part # EM-EL
2.4W 249LM 6500K CCT 120-277V

Red Option



Exit Sign
Model # 55301101 Part # EM-EX-R
2.2W 6500K CCT 120-277V

Green Option



Exit Sign Green Letters
Model # 55301102 Part # EM-EX-G
2.2W 6500K CCT 120-277V

Single Wet Rated



Emergency Light Fixture Single (Wet Rated)
Model # 55503101 Part # EM-ELR-H1
1.2W 131LM 6500K CCT 120-277V

Double Wet Rated



Emergency Light Fixture Double (Wet Rated)
Model # 55503201 Part # EM-ELR-H2
2.4W 263LM 6500K CCT 120-277V

Combo



Emergency Light/Exit Sign Combo
Model # 55502101 Part # EM-ELC-R
2.4W 263LM 6500K CCT 120-277V
Emergency Light/Exit Sign Combo Green Letters
Model # 55502102 Part # EM-ELC-G
2.4W 263LM 6500K CCT 120-277V

Combo with Remote Compatibility



**Emergency Light/Exit Sign Combo
with Remote Compatibility**
Model # 55502201 Part # EM-ELC-R-RC
2.4W 263LM 6500K CCT 120-277V



ETi Solid State Lighting
720 Northgate Parkway
Wheeling, IL 60090

855.384.7754 | www.ETiSSL.com