

ALSD | ALTAIR SURFACE MOUNT DOWNLIGHTS

5 CCT COLOR PREFERENCE®

KEY FEATURES

- Luminaire uses ETI's patented Color Preference® with 5 Selectable CCTs Standard (2700K, 3000K, 3500K, 4000K, 5000K); 3 Selectable CCTs for PIR Motion Sensor option (3000K, 4000K, 5000K)
- 90+ CRI (JA8 Title 24 Compliant)
- TRIAC Dimming (120V)
- PIR Motion Sensor option available
- Wet Location Rated

SPECIFICATIONS

Construction

- Extruded aluminum, powder coated white—engineered for lightweight handling and heat dissipation
- Complete fixture is fully sealed and sits flush against the ceiling with no gap, protecting luminaire from environmental contaminants
- Optional trim accessories: Black and Satin Nickel

Optics

- High impact, polymer diffuser lens for zero pixelation and overall visual comfort
- Uniform, even light distribution

Installation

- Field select CCT using integral switch behind the lens prior to installation. Ships at lowest Color Temperature.
- Works with standard j-box and pancake j-box* (See dimensional info on page 3)
- Works with 4" & 6" recessed housings (retrofit kit sold separately)

Electrical

- > 130,000 hour LEDs at L70 for reduced maintenance
- Operates at 120V, 60Hz
- TRIAC dimming, down to 10%* (120V)
- PIR Motion Sensor Info: 120°, at 11 feet sensing distance
- Operating Temperature: -4°F to 104°F (-20°C to 40°C)
- ETI's patented selectable CCT COLOR PREFERENCE® allows for easy field-adjustable color temperature selection with switch located inside fixture.

* Always consult dimmer manufacturer for proper use, installation and compatibility (some dimmers may require a neutral in the wall box).

Warranty

5-Year Standard Warranty. See terms at: ETISSL.com/warranty/

DATE:	PROJECT:
TYPE:	NOTES:
CATALOG #:	



Black & Satin Nickel
Clip-On Trim Accessories
Available for all models



Certifications & Test Data

- All luminaires are UL Listed (US, C) for Wet Location
- Adheres to LM63, LM79, LM80 and TM21 industry standards for photometric, lumen maintenance and lifetime calculations
- ENERGY STAR® rated (See Page 3 for search info.)
- Product can be used to comply with California Title 24 Efficiency Standards
- JA8 Title 24 Compliant
- Suitable for use in closets when installed in accordance to NEC Section 410.16 (A)(1) and 410.16 (C)(1)

LM 63

LM 79

LM 80

TM 21

IES

KEY DATA	
LUMEN RANGE	908 – 1357
WATTAGE RANGE	9.9 – 15.0
EFFICACY RANGE (LPW)	95 – 98 (BASED ON 3500K)
REPORTED LIFE (HOURS)	L70 / > 130,000

CATALOG LOGIC

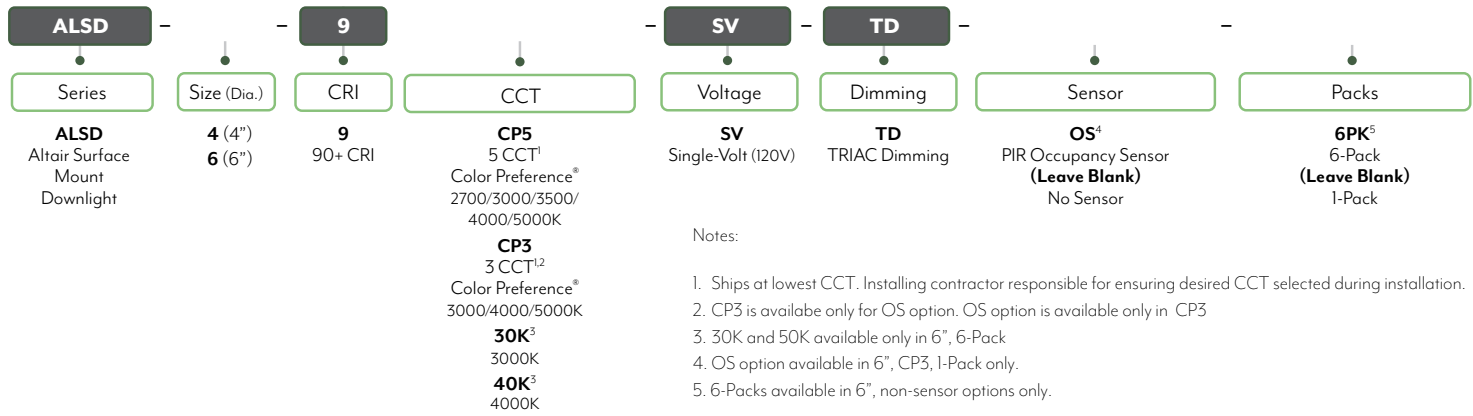

STOCK ORDERING INFORMATION

CATALOG PART NUMBER	ORDER NUMBER	DESCRIPTION	PACK SIZE	CRI	CCT	WATTS (NOM.)	LUMEN PKG. ¹	DELIVERED LUMENS	LPW	VOLTAGE	DIM	ENERGY STAR ²
ALSD SURFACE MOUNT DOWNLIGHTS, 5CCT												
ALSD-4-9CP5-SV-TD	63327101	4" Altair Surface Mount Downlight, CP5 – 1-Pack	1	90+	2700K	10	850	908	91	120V	TRIAC	YES
					3000K	10	850	952	95			
					3500K	10	850	970	98			
					4000K	10	850	972	98			
					5000K	10	850	950	95			
ALSD-6-9CP5-SV-TD	63328101	6" Altair Surface Mount Downlight, CP5 – 1-Pack	1	90+	2700K	15	1230	1232	84	120V	TRIAC	YES
					3000K	15	1230	1320	91			
					3500K	15	1230	1357	95			
					4000K	15	1230	1357	94			
					5000K	15	1230	1307	89			
ALSD-6-9CP5-SV-TD-6PK	63328101-6PK	6" Altair Surface Mount Downlight, CP5 – 6-Pack	6	90+	2700K	15	1230	1232	84	120V	TRIAC	YES
					3000K	15	1230	1320	91			
					3500K	15	1230	1357	95			
					4000K	15	1230	1357	94			
					5000K	15	1230	1307	89			
ALSD SURFACE MOUNT DOWNLIGHTS, SINGLE CCT												
ALSD-6-930K-SV-TD-6PK	63328111	6" Altair Surface Mount Downlight, 3000K – 6-Pack	6	90+	3000K	15	1230	1268	85	120V	TRIAC	YES
ALSD-6-940K-SV-TD-6PK	63328141	6" Altair Surface Mount Downlight, 4000K – 6-Pack	6	90+	4000K	15	1230	1310	89	120V	TRIAC	YES
ALSD SURFACE MOUNT DOWNLIGHT WITH PIR MOTION SENSOR, 3CCT												
ALSD-6-9CP3-SV-TD-OS	63328102	6" Altair Surface Mount Downlight, CP3 with PIR Occupancy Sensor – 1-Pack	1	90+	3000K	15	900	947	65	120V	TRIAC	YES
					4000K	15	900	1078	72			
					5000K	15	900	960	66			

Notes: 1. For more delivered lumens and test data see pages 3, or visit ETISSL.com 2. ENERGY STAR® search catalog part number. Example: ALSD-6-9CP5-SV-TD

AVAILABLE STOCK ACCESSORIES (must be ordered separately, field installed)

Catalog Part Number	Order Number	Description	Details
ALSD-6-TRIM-BL	70576101	Altair Series 6" Surface Mount Downlight Clip-On Black Trim	<p>6IN</p>
ALSD-6-TRIM-SN	70578101	Altair Series 6" Surface Mount Downlight Satin Clip-On Nickel Trim	
ALSD-4-TRIM-BL	70573101	Altair Series 4" Surface Mount Downlight Clip-On Black Trim	
ALSD-4-TRIM-SN	70575101	Altair Series 4" Surface Mount Downlight Satin Clip-On Nickel Trim	
ALSD-6-RETROFIT KIT	70605101	Altair Series 6" Friction Clips with E26 adapter	
ALSD-4-RETROFIT KIT	70604101	Altair Series 4" Friction Clips with E26 adapter	

DIMENSIONS / DETAILS

4-Inch

Unit Weight
0.37 lb.

Twist-off lens for easy install and CCT selection

CP5:
Ships at 2700K

6-Inch

Unit Weight
0.51 lb.

6-Inch with Motion

Unit Weight
0.53 lb.

Twist-off lens for easy install and CCT selection

CP3: Ships at 3000K

MOTION SENSOR OPERATION

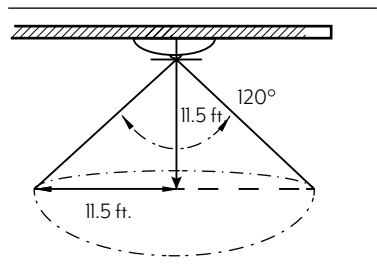

30 Second Hold Time
Non-adjustable

Mounting Hole Dimensions

Fits standard j-box and pancake junction boxes

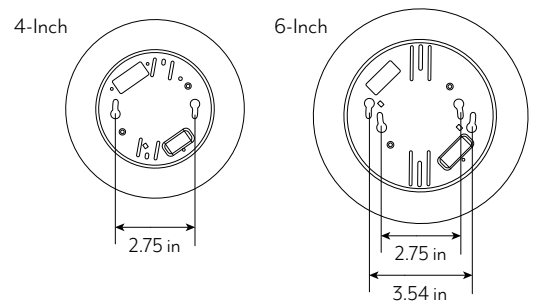

PERFORMANCE / DATA

Lumen Maintenance

Ambient Temp.	TM-21 Lumen Maintenance (54,000 hours)
25° C (77° F)	> 87%
Ambient Temp.	TM-21 Theoretical L70 (hours)
25° C (77° F)	> 130,000

Load Information

Power Factor	> 0.90
THD	< 20%
Frequency	60 Hz
Low Temp Start / Max Temp	-20° C (-4° F) / 40° C (104° F)

DIMMER COMPATIBILITY LIST

DIMMER BRAND	SERIES	DIMMER MODEL
TRIAC DIMMERS		
LUTRON	Maestro C-L	MACL-153M
LUTRON	Skylark C-L	SCL-153P
LUTRON	Diva C-L	DVCL-153P
LEGRAND	Radiant	RHCL453PTC
LEGRAND	Harmony	DCL453PTCCCV6
LEGRAND	Harmony	HCL453PTCCCV6
LUTRON	Skylark	CTCL-153PDH-WH
LUTRON	Toggle	TGCL-153PH-WH
LEVITON	Illumena Tech	R50-IPL06-10M
LUTRON	Diva C-L	DVWCL-153PH-WH
LUTRON	Diva	DVCL-153P
LUTRON	Maestro	PD-6WCL
LEGRAND	Radiant	RHCL453PTC

* Always consult dimmer manufacturer for proper use, installation and compatibility (some dimmers may require a neutral in the wall box).



ETI Lighting
4873 Thurmon Tanner Parkway,
Flowery Branch, GA 30542

855.384.7754 | www.etissl.com
Quotes: quotes@etissl.com
Orders: etiororders@etissl.com

All specifications are subject to change without notice.
All reported values are typical values, measured under laboratory conditions @ 25° C (77° F).
Actual performance can vary slightly as a result of end-user application & environment.

PHOTOMETRIC SAMPLES

5CCT

4IN

Luminaire Data: 120V
ALSD-6-9CP5-SV-TD, 3500K

IES

CCT & CRI	3500K, 90+ CRI
DELIVERED LUMENS	970
WATTAGE	9.9W
EFFICACY	98
BEAM ANGLE	50%=111.0° 10%=168.3°
SPACING	0° = 1.23 90° = 1.24

Photometric values based on tests performed in compliance with LM-63 & LM-79

Zonal Lumen Summary

Zone	Lumens	% Luminaire
0-30	250.9	25.90%
0-40	409	42.20%
0-60	720.3	74.30%
0-90	943.7	97.30%
0-180	969.8	100.0%

Candela Plot

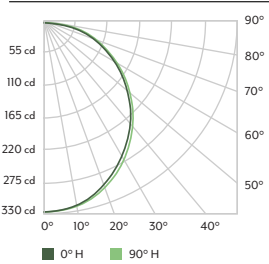

6IN

Luminaire Data: 120V
ALSD-6-9CP5-SV-TD, 3500K

IES

CCT & CRI	3500K, 90+ CRI
DELIVERED LUMENS	1357
WATTAGE	14.3W
EFFICACY	95
BEAM ANGLE	50%=110.7° 10%=164.4°
SPACING	0° = 1.24 90° = 1.24

Photometric values based on tests performed in compliance with LM-63 & LM-79

Zonal Lumen Summary

Zone	Lumens	% Luminaire
0-30	358.1	26.40%
0-40	583.8	43%
0-60	1,025.50	75.60%
0-90	1,320.10	97.30%
0-180	1,357.20	100.0%

Candela Plot

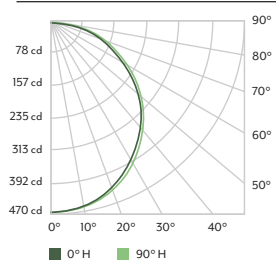

SINGLE CCT

6IN

Luminaire Data: 120V
ALSD-6-930K-SV-TD

IES

CCT & CRI	3000K, 90+ CRI
DELIVERED LUMENS	1268
WATTAGE	14.9W
EFFICACY	72
BEAM ANGLE	50%=164.6° 10%=110.5°
SPACING	0° = 1.24 90° = 1.24

Photometric values based on tests performed in compliance with LM-63 & LM-79

Zonal Lumen Summary

Zone	Lumens	% Luminaire
0-30	334.6	26.40%
0-40	544.3	42.90%
0-60	956.1	75.40%
0-90	1,232.20	97.20%
0-180	1,267.60	100%

Candela Plot

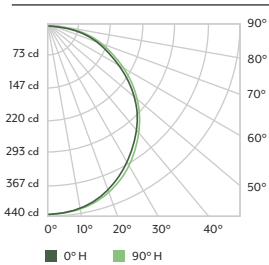

6IN

Luminaire Data: 120V
ALSD-6-940K-SV-TD

IES

CCT & CRI	4000K, 90+ CRI
DELIVERED LUMENS	1310
WATTAGE	14.7W
EFFICACY	72
BEAM ANGLE	50%=164.7° 10%=110.9°
SPACING	0° = 1.27 90° = 1.25

Photometric values based on tests performed in compliance with LM-63 & LM-79

Zonal Lumen Summary

Zone	Lumens	% Luminaire
0-30	344.8	26.30%
0-40	561.5	42.90%
0-60	987.5	75.40%
0-90	1,273.40	97.20%
0-180	1,309.70	100.0%

Candela Plot

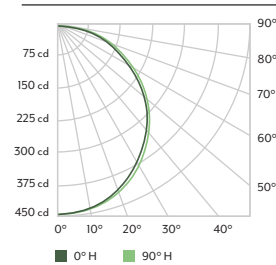

3CCT with OC Sensor

6IN

Luminaire Data: 120V
ALSD-6-9CP3-SV-TD-OS, 4000K

IES

CCT & CRI	4000K, 90+ CRI
DELIVERED LUMENS	1078
WATTAGE	15.0W
EFFICACY	72
BEAM ANGLE	50%=113.2° 10%=171.7°
SPACING	0° = 1.27 90° = 1.25

Photometric values based on tests performed in compliance with LM-63 & LM-79

Zonal Lumen Summary

Zone	Lumens	% Luminaire
0-30	268.3	24.9%
0-40	439.1	40.7%
0-60	780.4	72.4%
0-90	1,031.8	95.7%
0-180	780.4	100.0%

Candela Plot

